

KOMATSU®

PC200-8M0 PC200LC-8M0

PC
200

HORSEPOWER

Gross: 110 kW 147 HP / 2000 min⁻¹

Net: 103 kW 138 HP / 2000 min⁻¹

OPERATING WEIGHT

PC200-8M0: 19800 – 20500 kg

PC200LC-8M0: 20700 – 21700 kg

BUCKET CAPACITY

0.50 – 1.20 m³



Photos may include optional equipment.

WALK-AROUND





ECOLOGY & ECONOMY

- ▮ Low Fuel Consumption by Total Control of the Engine, Hydraulic and Electronic System
- ▮ Low Emission Engine
- ▮ Low Operation Noise

COMFORT & SAFETY

- ▮ Large Comfortable Cab
- ▮ ROPS Cab (ISO 12117-2)
- ▮ Rear View Monitor System (Optional)

* Information and Communication Technology

ICT* & KOMTRAX

- ▮ Large Multi-lingual High Resolution Liquid Crystal Display (LCD) Monitor
- ▮ Equipment Management Monitoring System
- ▮ KOMTRAX

MAINTENANCE & RELIABILITY

- ▮ Easy Maintenance
- ▮ High Rigidity Work Equipment



	PC200-8M0	PC200LC-8M0
HORSEPOWER	Gross: 110 kW 147 HP / 2000 min ⁻¹ Net: 103 kW 138 HP / 2000 min ⁻¹	110 kW 147 HP / 2000 min ⁻¹ 103 kW 138 HP / 2000 min ⁻¹
OPERATING WEIGHT	19800 – 20500 kg	20700 – 21700 kg
BUCKET CAPACITY	0.50 – 1.20 m ³	0.50 – 1.20 m ³

ECOLOGY & ECONOMY

Low Fuel Consumption

The newly-developed Komatsu SAA6D107E-1 engine enables NOx emissions to be significantly reduced with the accurate multi-staged fuel injection by the engine controller. It improves total engine durability using the high-pressure fuel injection system developed specifically for construction machinery. This excavator significantly reduces hourly fuel consumption using the highly-efficient matching techniques of the engine and hydraulic unit and also provides features that promote energy-saving operations such as the E mode and ECO gauge.

Fuel consumption

7% reduced

Vs. PC200-8
Based on typical work pattern collected via KOMTRAX.
Fuel consumption varies depending on job conditions.

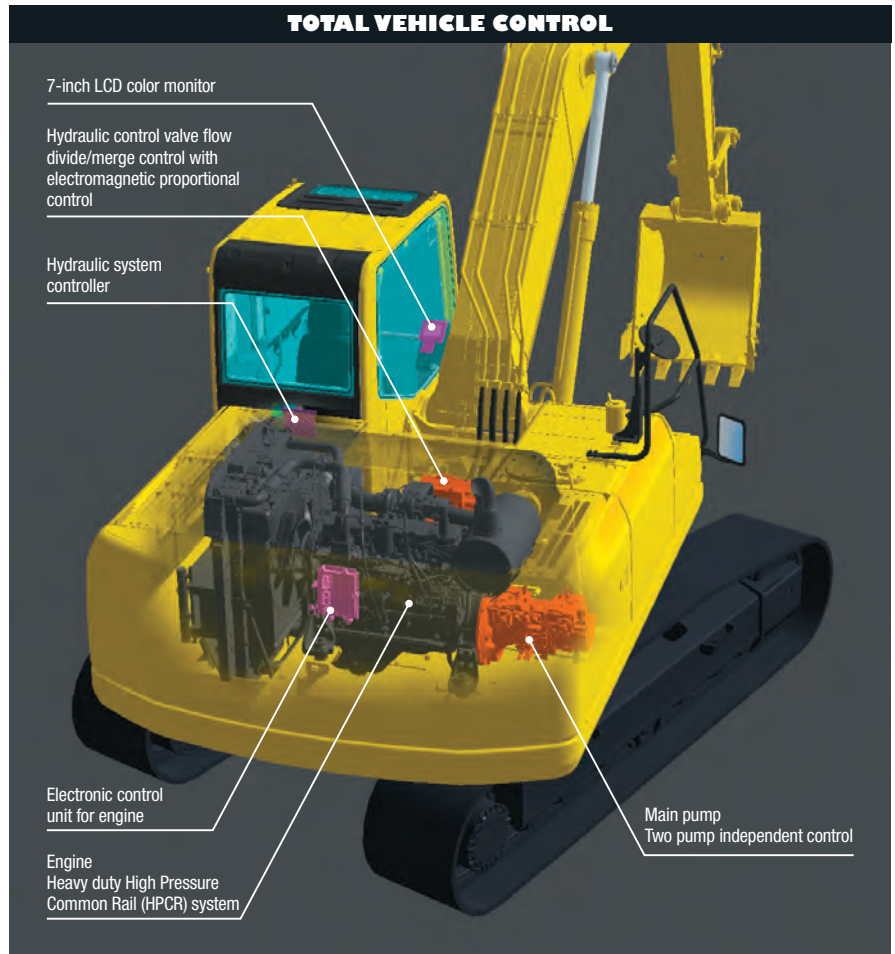

Komatsu Technology

Komatsu develops and produces all major components, such as engines, electronics and hydraulic components, in house. With this “Komatsu Technology” and adding customer feedback, Komatsu is achieving great advancements in technology. To achieve both high levels of productivity and economical performance, Komatsu has developed the main components with a total control system. The result is a new generation of high performance and environment-friendly excavators.



Low Emission Engine

Komatsu SAA6D107E-1 reduced NOx emission by 29% compared with the PC200-7. This engine is U.S. EPA Tier 3 and EU Stage 3A emissions equivalent.

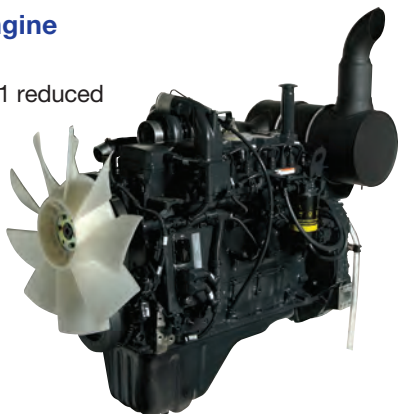

Low Operation Noise

Enables a low noise operation using the low-noise engine and methods to cut noise at source.

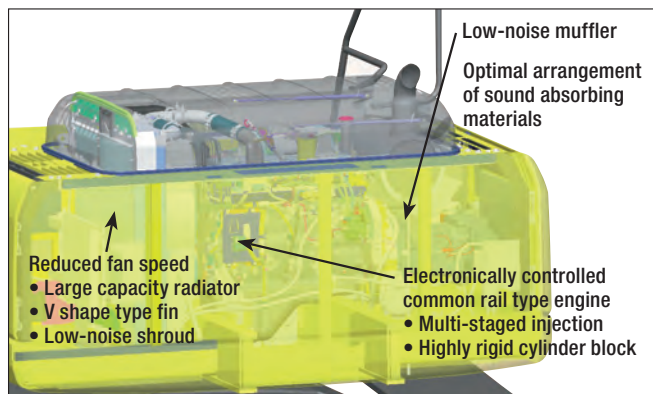

Idling Caution

To prevent unnecessary fuel consumption, an idling caution is displayed on the monitor, if the engine idles for 5 minutes or more.



ECO Gauge that Assists Energy-saving Operations

Equipped with the ECO gauge that can be recognized at a glance on the right of the multi-function color monitor for environment-friendly energy-saving operations. Allows focus on operation in the green range with reduced CO₂ emissions and efficient fuel consumption.



ECO gauge

Working Modes Selectable

The PC200-8M0 excavator is equipped with six working modes (P, E, L, B, ATT/P and ATT/E mode). Each mode is designed to match engine speed and pump output to the application. This provides the flexibility to match equipment performance to the job at hand.

Working Mode	Application	Advantage
P	Power mode	<ul style="list-style-type: none"> • Maximum production/power • Fast cycle times
E	Economy mode	<ul style="list-style-type: none"> • Good cycle times • Better fuel economy • Adjustable in 4 stages
L	Lifting mode	<ul style="list-style-type: none"> • Suitable attachment speed • Lifting capacity is increased 7% by raising hydraulic pressure.
B	Breaker mode	<ul style="list-style-type: none"> • Optimum engine rpm, hydraulic flow
ATT/P	Attachment Power mode	<ul style="list-style-type: none"> • Optimum engine rpm, hydraulic flow, 2way • Power mode
ATT/E	Attachment Economy mode	<ul style="list-style-type: none"> • Optimum engine rpm, hydraulic flow, 2way • Economy mode

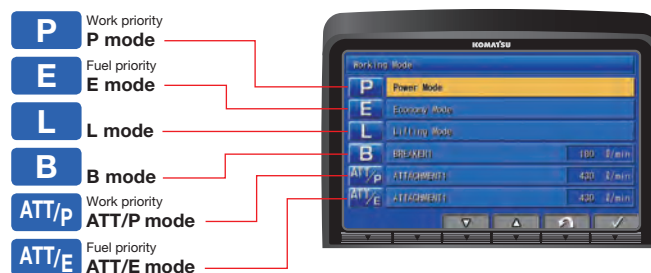

The economy mode is adjustable in 4 stages. It is selectable from the economy mode adjustment selection menu as appropriate. The power output will be reduced when adjust from E0 to E3, however, the fuel consumption will be better.

E0	Economy mode
E1	Economy adjustment 1
E2	Economy adjustment 2
E3	Economy adjustment 3

Large Digging Force

When press the left knob switch which is called the one-touch power max. switch and when it is kept pressed, this function temporarily increases digging force for 8.5 seconds of operation.

Maximum arm crowd force (ISO 6015):

101 kN (10.3 t) ➔ **108 kN (11.0 t)** **7% UP**
(with Power Max.)

Maximum bucket digging force (ISO 6015):

138 kN (14.1 t) ➔ **149 kN (15.2 t)** **8% UP**
(with Power Max.)

Measured with Power Max. function, 2925 mm arm and ISO 6015 rating.

One-touch power max. switch

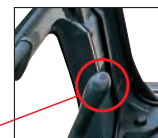

COMFORT



Low Cab Noise

The newly-designed cab is highly rigid and has excellent sound absorption ability. Thorough improvement of noise source reduction and use of low noise engine, hydraulic equipment, and air conditioner allows this machine to generate a low level of noise.

Low Vibration with Cab Damper Mounting

PC200-8M0 uses viscous damper mounting for cab that incorporates longer stroke and the addition of a spring. The new cab damper mounting combined with high rigidity deck aids vibration reduction at operator seat.

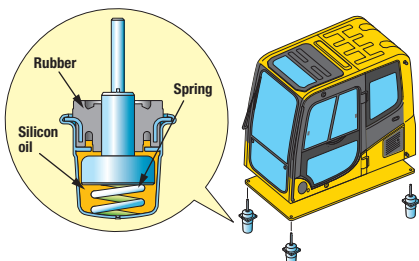

Wide Newly-designed Cab

Newly-designed wide spacious cab includes seat with reclining backrest. The seat height and longitudinal inclination are easily adjusted using a pull-up lever. You can set the appropriate operational posture of armrest together with the console. Reclining the seat further enables you to place it into the fully flat state with the headrest attached.



Pressurized Cab

Optional air conditioner, air filter and a higher internal air pressure minimize external dust from entering the cab.

Automatic Air Conditioner (A/C) (Optional)

Enables you to easily and precisely set cab atmosphere with the instruments on the large LCD. The bi-level control function keeps the operator's head and feet cool and warm respectively. This improved air flow function keeps the inside of the cab comfortable throughout the year. Defroster function keeps front glass clear.

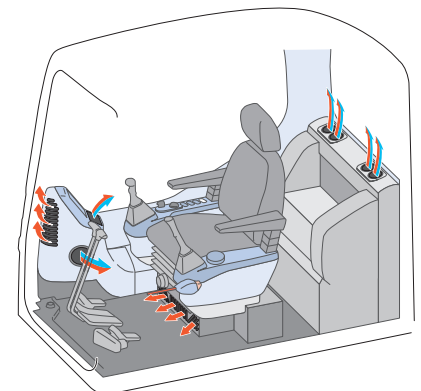

SAFETY

ROPS Cab

The machine is equipped with a ROPS cab that conforms to ISO 12117-2 for excavators as standard equipment. The ROPS cab has high shock-absorption performance, featuring excellent durability and impact strength. It also satisfies the requirements of OPG top guard level 1 (ISO 10262) for falling objects. Combined with the retractable seat belt, The ROPS cab protects the operator in case of tipping over and against falling objects.



Slip-resistant Plates

Highly durable slip-resistant plates maintain superior traction performance for the long term.



Pump/Engine Room Partition

Pump/engine room partition prevents oil from spraying onto the engine if a hydraulic hose should burst.

Lock Lever

Locks the hydraulic pressure to prevent unintentional movement. Neutral start function allows machine to be started only in lock position.



Large Side-view, Rear and Sidewise Mirrors

Enlarged left-side mirror and addition of rear and side mirror allow the PC200-8M0 to meet the visibility requirements (ISO 5006).



Rear View Monitor System (Optional)

The operator can view the rear of the machine with a color monitor screen.



Rear view image on monitor

Thermal and Fan Guards

Thermal and fan guards are placed around high-temperature parts of the engine and fan drive.



LARGE HIGH RESOLUTION LCD MONITOR



Large Multi-lingual High Resolution LCD Monitor

A large user-friendly high resolution LCD color monitor enables safe, accurate and smooth work. Visibility and resolution are further improved compared with current 7-inch large LCD. Simple and easy to operate switches. Function keys facilitate multi-function operations. Displays data in 13 languages to globally support operators around the world.

Indicators

- | | |
|----------------------------------|-----------------------------------|
| 1 Auto-decelerator | 5 Hydraulic oil temperature gauge |
| 2 Working mode | 6 Fuel gauge |
| 3 Travel speed | 7 ECO gauge |
| 4 Engine water temperature gauge | 8 Fuel consumption gauge |
| | 9 Function switches menu |

Basic operation switches

- | | |
|-------------------------|---------------------|
| 1 Auto-decelerator | 4 Buzzer cancel |
| 2 Working mode selector | 5 Wiper |
| 3 Traveling selector | 6 Windshield washer |

Basic operation switches

Function switches

A/C operation switches (Optional)

Supports Efficiency Improvement

The main screen displays advices for promoting energy-saving operations as needed. The operator can use the ECO guidance menu to check the operation records, ECO guidance records, average fuel consumption logs, etc.



ECO guidance



ECO guidance menu

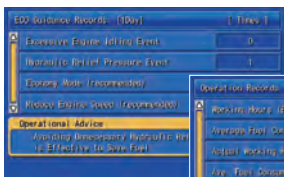

ECO guidance records



Operation records



Average fuel consumption logs

Equipment Management Monitoring System

Monitor function

Controller monitors engine oil level, coolant temperature, battery charge air clogging, etc. If the controller finds any abnormality, it is displayed on the LCD.



Maintenance function

The monitor informs replacement time of oil and filters on the LCD when the replacement interval is reached.

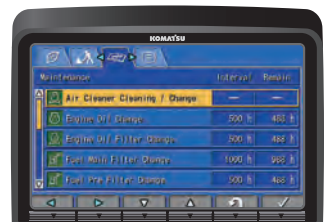

Trouble data memory function

Monitor stores abnormalities for effective troubleshooting.



Assists Customer's Equipment Management and Contributes to Fuel Cost Cutting

Equipment Management Support

KOMTRAX terminal installed on your machine collects and sends information such as machine location, working record, machine conditions, etc. using wireless communication. You can review the KOMTRAX data remotely via the online application. KOMTRAX not only gives you the informations on your machine, but also the convenience of managing your fleet on the Web.

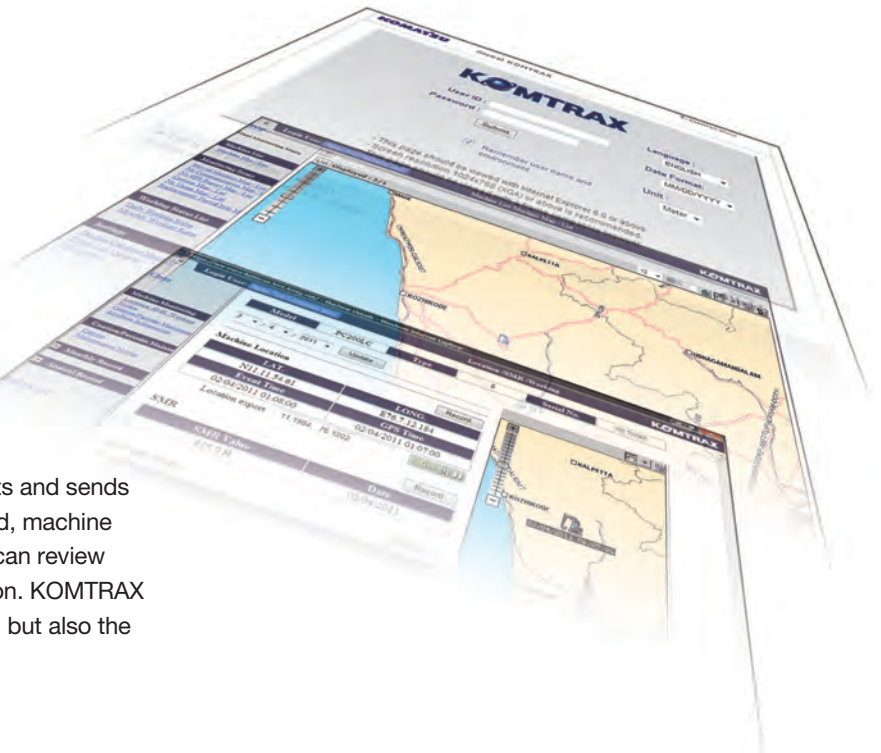

Location

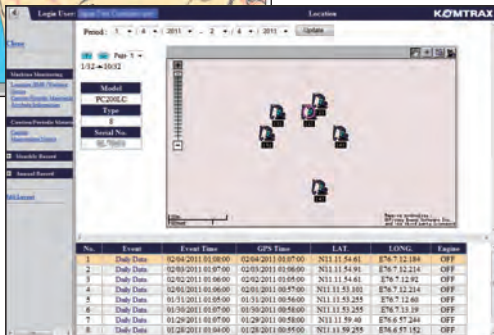

Movement generated position



Operation map



Monthly status summary

Energy-saving Operation Support Report

KOMTRAX can provide various useful information which includes the energy-saving operation support report created based on the operating information of your machine such as fuel consumption and idle time.

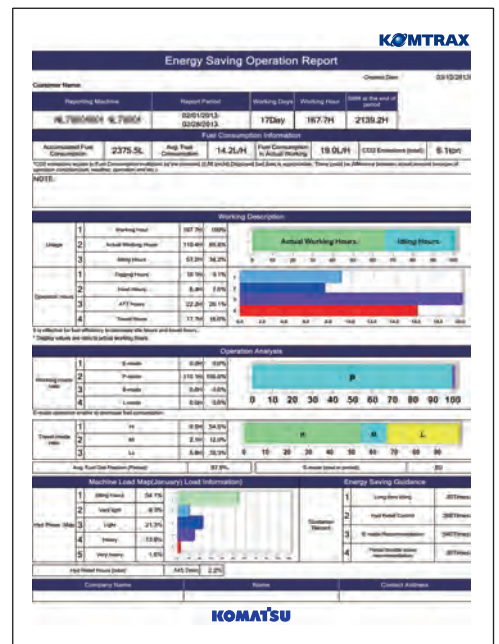

Image

MAINTENANCE

Side-by-side Cooling

Since radiator, aftercooler and oil cooler are arranged in parallel, it is easy to clean, remove and install them. Radiator, aftercooler, and oil cooler made of aluminum have high cooling efficiency and are easily recycled.

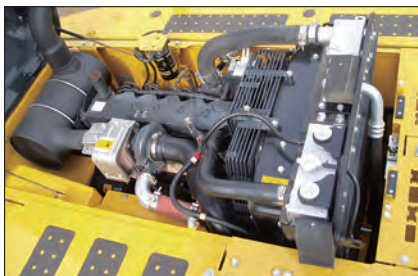

Equipped with the Fuel Pre-filter (With Water Separator)

Removes water and contaminants in the fuel to prevent fuel problems. (With built-in priming pump)



Washable Cab Floormat

The PC200-8M0's cab floormat is easy to keep clean. The gently inclined surface has a flanged floormat and drainage holes to facilitate runoff.



Easy Access to Engine Oil Filter and Fuel Drain Valve

Engine oil filter and fuel drain valve are remote mounted to improve accessibility.



Equipped with the Drain Valve as Standard

Prevents clothes and the ground from becoming contaminated due to oil leakage when replacing the engine oil.



Large-capacity Fuel Tank and Rustproof Treatment

400-liter high-capacity fuel tank. Effective corrosion resistance using rust-proof treatment.

Sloping Track Frame

Prevents dirt and sand from accumulating and allows easy mud removal.

Gas Assisted Engine Hood Damper Cylinders

The engine hood can be easily opened and closed with the assistance of the gas assisted engine hood damper cylinders.



Long-life Oil, Filter

Uses high-performance filtering materials and long-life oil. Extends the oil and filter replacement interval.



Engine oil & Engine oil filter	every 500 hours
Hydraulic oil	every 5000 hours
Hydraulic oil filter	every 1000 hours

Auto A/C Filter (Optional)

The A/C filter is removed and installed without the use of tools facilitating filter maintenance.



Internal A/C filter

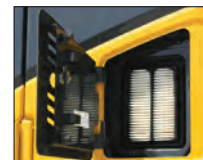

External A/C filter

RELIABILITY

High Rigidity Work Equipment

Boom and arms are constructed of thick plates of high tensile strength steel. In addition, these structures are designed with large cross-sectional areas and generous use of castings. The result is working attachments that exhibit long term durability and high resistance to bending and torsional stress.

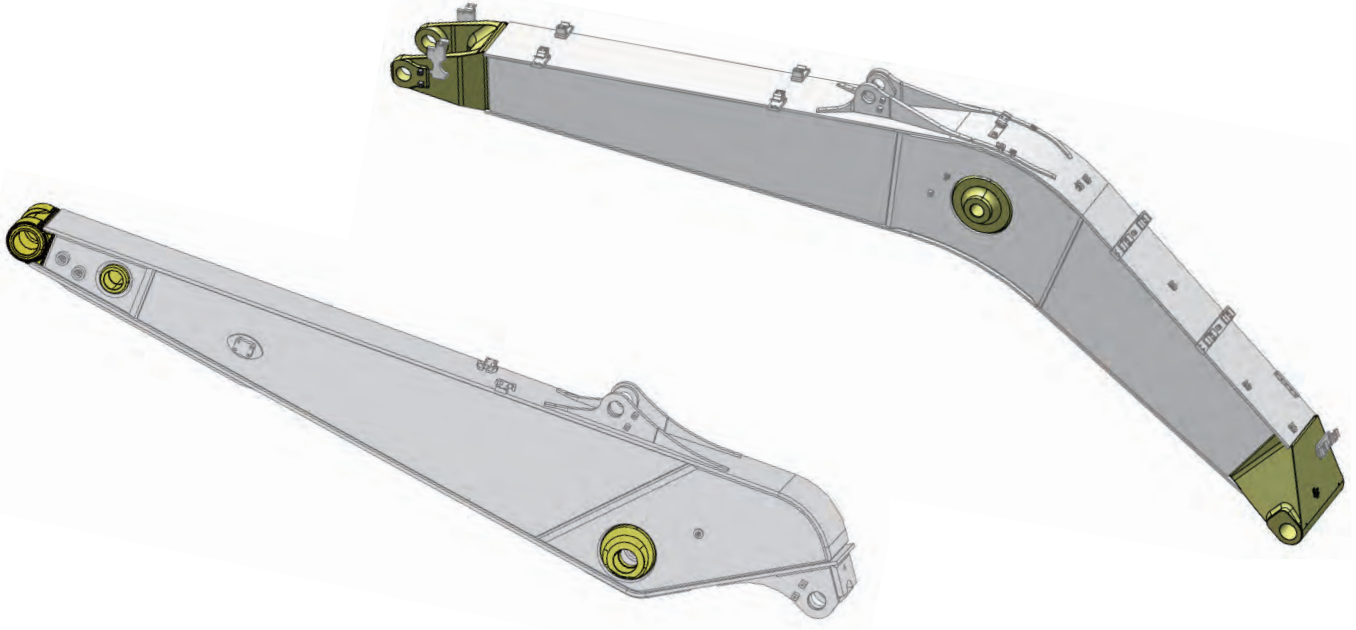

Sturdy Frame Structure

The revolving frame, center frame and undercarriage are designed by using the most advanced three-dimensional CAD and Finite Element Method (FEM) analysis technology.

Highly Reliable Electronic Devices

Exclusively designed electronic devices have passed severe testing.

- Controller
- Sensors
- Connectors
- Heat resistant wiring

Reliable Components

All of the major machine components, such as engine, hydraulic pumps, hydraulic motors and control valves are exclusively designed and manufactured by Komatsu.

Grease Sealed Track

PC200-8M0 uses grease sealed tracks for extended undercarriage life.

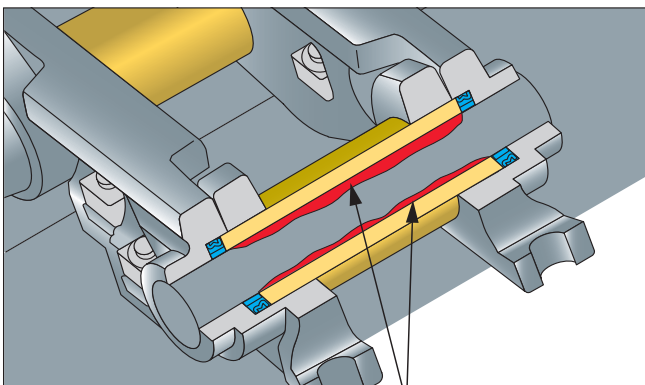

Strengthened Track Link

PC200-8M0 uses strengthened track links, providing superb weight distribution and extend durability.



SPECIAL SPECS.

Attachment Piping Spec.

Equips PC200-8M0 for breaker and crusher installation. Hydraulic flow rate can be regulated by setting Breaker Mode on monitor panel during breaker operation.



Accumulator



Pilot filter



Additional filter for breaker



Heavy duty arm

Stop valve



Operating pedal



Super Long Front Spec.

Super long front attachment boasts a huge digging reach. An excavator with this attachment highly improves working efficiency in various works such as river conservation, lake dredging, slope finishing and materials carrying where an extensively long reach is required.

Specifications

Spec/ Model	PC200-8M0	PC200LC-8M0	
SLF Type	15 m	15 m	18 m
Operating Weight	22010 kg	23100 kg	26680 kg
Bucket Capacity	0.45 m ³	0.45 m ³	0.29 m ³
Max. Digging Reach	15250 mm	15250 mm	18340 mm
Max. Digging Height	13730 mm	13730 mm	15380 mm
Max. Digging Depth	11530 mm	11530 mm	14610 mm



Swing Yarder & Logging Spec. (Forestry)



Swing Yarder spec

A Swing Yarder & Logging spec is a mobile piece of heavy duty forest equipment.

A Swing Yarder has function to pull log on anchor position (on parallel or side condition) from the stump to the landing and it is allowed to operate by swing movement for arranging logs.

A Logging spec equipped with a grapple used for gathering logs, discharging from vessels and loading to trucks.



Logging spec

Specifications

Spec/ Model	PC200-8M0	
Machine Spec.	Swing Yarder	Logging
Operating Weight	23700 kg	22010 kg
Reinforced Boom/ Arm	For Swing Yarder	For Logging
Forestry Bucket	0.8 m ³ with horn	
Forestry Guard	Cab: cab window, side cover (both side), battery case, deck guard, HD undercover and boom cylinder	
Under Carriage	Reinforced track frame, double flange carrier roller, 3-track roller guards (each side), track frame undercover	
Track Shoe	800 mm shoe width and track link with snap ring	800 mm shoe width and track link (with snap ring: optional)
Winch	Komatsu winch, max line pull 14.6 ton	-
Travel Motor	Drawbar pull 13% up	-

ATTACHMENT

Hydraulic Breaker

The hydraulic breaker is an attachment tool used for crushing rock beds and paved surfaces, demolishing concrete structures, etc. The large gas chamber, ideal gas pressure ratio, and long-stroke piston deliver a powerful impact force. Since the breaker unit does not require an accumulator, the number of parts has been reduced, resulting in lower maintenance costs.



Hydraulic Quick Coupler

All kinds of attachment can be mounted quickly without modification.

- Lifting eye capacity: 12000 kg
- Weight: 295 kg

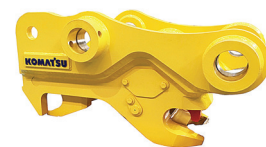

Power Fork Grapple

- Weight: 820 kg
- Opening width: 2080 mm
- Overall length: 1880 mm
- Claw width: 700 mm



Easy mounting and detaching by roller pin

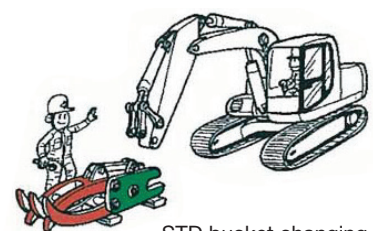

STD bucket changing without detaching link

STANDARD & OPTIONAL EQUIPMENT

Standard and Optional Equipment

◎ : Standard equipment ○ : Optional equipment - : Not available		PC200-8M0					PC200LC-8M0		
		STD	ATT Piping	Super Long Front	Swing Yarder	Forestry (Logging)	STD	ATT Piping	Super Long Front
Boom	5700 mm Strengthened boom	◎	-	-	-	-	◎	-	-
	5700 mm Strengthened boom with 1 additional piping	-	◎	-	-	-	-	◎	-
	8600 mm Super long front boom (for 15m SLF)	-	-	◎	-	-	-	-	◎
	10300 mm Super long front boom (for 18m SLF)	-	-	-	-	-	-	-	○
	5700 mm Swing yarder boom, strengthened	-	-	-	◎	-	-	-	-
	5700 mm Logging boom, strengthened	-	-	-	-	◎	-	-	-
Arm	2925 mm Strengthened arm assembly	◎	-	-	-	-	◎	-	-
	2410 mm Arm assembly	○	-	-	-	-	○	-	-
	1840 mm Arm assembly	○	-	-	-	-	○	-	-
	2925 mm Strengthened arm assembly with 1-additional piping	-	◎	-	-	-	-	◎	-
	2410 mm Strengthened arm assembly with 1-additional piping	-	○	-	-	-	-	○	-
	6400 mm Super long front arm assembly (for 15m SLF)	-	-	◎	-	-	-	-	◎
	8200 mm Super long front arm assembly (for 18m SLF)	-	-	-	-	-	-	-	○
	2925 mm Swing yarder arm assembly ,strengthened	-	-	-	◎	-	-	-	-
2925 mm Forestry arm assembly, strengthened	-	-	-	-	◎	-	-	-	
Bucket	0.80 m ³ Bucket	○	○	-	-	-	○	○	-
	0.93 m ³ Bucket	○	○	-	-	-	○	○	-
	1.05 m ³ Bucket	○	○	-	-	-	○	○	-
	0.45 m ³ Bucket for super long front	-	-	◎	-	-	-	-	◎
	0.29 m ³ Bucket for super long front	-	-	-	-	-	-	-	○
	0.80 m ³ Forestry bucket	-	-	-	◎	◎	-	-	-
Bucket hook	Bucket hook	○	○	○	-	-	○	○	○
Shoe	800 mm Triple grouser	◎	◎	◎	-	◎	◎	◎	◎
	700 mm Triple grouser	○	○	○	-	-	○	○	○
	600 mm Triple grouser	○	○	○	-	-	○	○	○
	800 mm Triple grouser with snap ring	-	-	-	◎	○	-	-	-
Counterweight	Standard counterweight, 3.7 ton	◎	◎	-	◎	◎	◎	◎	-
	Heavy counterweight, 5.1 ton	-	-	◎	-	-	-	-	◎
	Heavy counterweight, 7.5 ton	-	-	-	-	-	-	-	○
Cooler	Cooler	◎	◎	◎	◎	◎	◎	◎	◎
	Auto air conditioner	○	○	○	-	-	○	○	○
Seat	Seat, rigid type	◎	◎	◎	◎	◎	◎	◎	◎
	Seat, suspension	○	○	○	-	-	○	○	○
CAB	Cab front full guard level 1 (ISO 10262)	○	○	○	-	-	○	○	○
	Cab OPG top guard level 2 (ISO 10262)	○	○	○	-	-	○	○	○
	Rear view camera system	○	○	○	-	-	○	○	○
	Beacon lamp	○	○	○	-	-	○	○	○
	Anti-theft guard for monitor and pump controller	○	○	○	-	-	○	○	○
	Sun visor	○	○	○	-	-	○	○	○
	Sun roller blind	○	○	○	-	-	○	○	○
Others	2-Working light, additional on boom cylinder	○	○	○	-	-	○	○	○
	Air pre cleaner, engine	○	○	○	-	-	○	○	○
	Fuel refill pump	○	○	○	-	-	○	○	○
	Track frame under cover	○	○	○	◎	◎	○	○	○
	One service valve	○	-	-	-	-	○	-	-
	Arm holding valve	○	○	-	○	○	○	○	-
Special spec	1-Attachment piping spec	-	◎	-	-	-	-	◎	-
	Swing yarder spec	-	-	-	◎	-	-	-	-
	Forestry spec (Logging)	-	-	-	-	◎	-	-	-

Standard and optional equipment may vary by country. Please consult your Komatsu dealer for details.

Other Standard Equipment

ENGINE:

- Automatic engine warm-up system
- Dry type air cleaner, double element
- Engine, Komatsu SAA6D107E-1
- Engine overheat prevention system
- Radiator and oil cooler dust proof net
- Suction fan

ELECTRICAL SYSTEM:

- Alternator, 24 V/35 A
- Auto-decelerator
- Batteries, 2 X 12 V/110 Ah
- Starting motor, 24 V/4.5 kW
- Working light, 5 (Boom, boom cylinder, RH and 2 on cab)

HYDRAULIC SYSTEM:

- Boom holding valve
- Power maximizing system
- Pressure Proportional Control (PPC) hydraulic control system
- Working mode selection system

GUARDS AND COVERS:

- Fan guard structure
- Track guiding guard, center section

UNDERCARRIAGE:

- Hydraulic track adjusters (Each side)
- Track roller
 - PC200-8M0, 7 each side
 - PC200LC-8M0, 9 each side
- Track shoe, 800 mm triple grouser

OPERATOR ENVIRONMENT:

- Equipment management monitoring system
- Large multi-lingual high resolution LCD monitor
- Rear view mirrors (RH, LH, rear, sidewise)
- ROPS cab (ISO 12117-2)
- Seat belt
- FM/AM radio

OTHER EQUIPMENT:

- Counterweight
- Electric horn
- Rear reflector
- Slip-resistant plates
- Travel alarm
- Komtrax system

Optional Equipment

- Cab front full height guard level 1 (ISO 10262)



- OPG top guard level 2 (ISO 10262)



- Rain visor



- Air pre-cleaner



- Strengthened track frame undercover



- Sun visor



- Seat, suspension



- Additional 2-working lamp on boom cylinder



- Fuel refill pump



- Beacon lamp



- Sun roller blind



- The anti-theft devices: Monitor guard and Pump controller guard

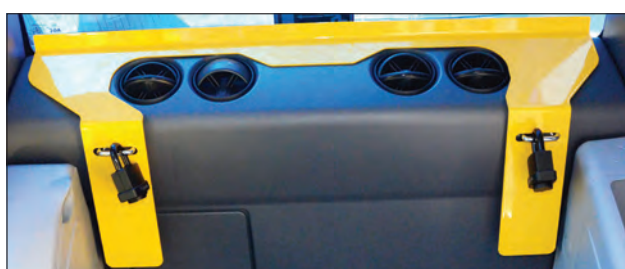

KOMATSU BRAND BUCKET

KOMATSU Brand Bucket

Me Bucket

- Low resistant excavation
- High fuel efficiency
- High productivity

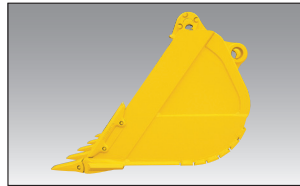

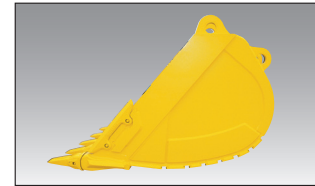

Conventional



Me Bucket

Category and Feature

Category	Load / Wear / Soil (Application)	Category	Load / Wear / Soil (Application)
General Purpose GP 	Load Machine power is mostly medium, but occasionally high. Bucket movements are smooth with minor shock load. Bucket penetrates easily. Wear Material is lightly abrasive. Some sand may be medium abrasive. Soil Mostly loose sand, gravel and finely broken materials.	Heavy Duty HD 	Load Machine power is high during majority of the work. Medium, but continuous shock load. Wear Material is abrasive. Light scratch marks can be seen at the bucket. Soil Limestone, shot rock, compact mix of sand, gravel and clay.

Bucket Line-up

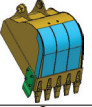
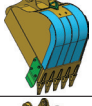
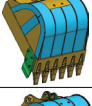
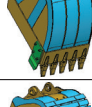
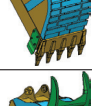
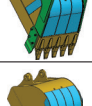
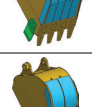
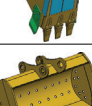
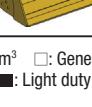
Category	Bucket Type	Image	Bucket Capacity (m³)		Bucket Width (mm)		Weight (kg)	Number of Tooth	Boom + Arm (m)					Tooth Type	
			SAE, PCSA	CECE	Without Side Cutter	With Side Cutter			5.7+1.8	5.7+2.4	5.7+2.9	8.6+6.4	10.3+8.2	Vertical	Horizontal
Excavating Bucket	GP		0.80	0.70	1045	1170	630	5	○	○	○	-	-		✓
			0.93	0.80	1200	1325	720	5	□	□	●	-	-		✓
			1.03	0.90	1330	1455	850	6	□	□	×	-	-		✓
	Me Bucket		1.05	0.90	1085	1210	750	5	□	□	●	-	-		✓
	HD		1.00	0.90	1348	1473	915	5	●	●	■	-	-		✓
Forestry Bucket	GP		0.80	0.70	1045	1170	604	5	-	-	○	-	-		✓
SLF Bucket	GP		0.45	0.40	832	957	325	4	-	-	-	○	×		✓
			0.29	0.26	600	725	315	3	-	-	-	×	○		✓
Ditch Cleaning Bucket	-		0.80	-	1800	-	552	-	-	-	-	-	-	-	-

○: General purpose use, density up to 1.8 t/m³ □: General purpose use, density up to 1.5 t/m³
 ●: Light duty work, density up to 1.2 t/m³ ■: Light duty work, density up to 0.9 t/m³ ×: Not usable ✓: Selectable

SPECIFICATIONS



ENGINE

Model Komatsu SAA6D107E-1
 Type Water-cooled, 4-cycle, direct injection
 Aspiration Turbocharged, aftercooled
 Number of cylinders 6
 Bore 107 mm
 Stroke 124 mm
 Piston displacement 6.69 L
 Horsepower:
 SAE J1995 Gross 110 kW 147 HP
 ISO 9249 / SAE J1349 Net 103 kW 138 HP
 Rated rpm 2000 min⁻¹
 Fan drive method for radiator cooling Mechanical
 Governor All-speed control, electronic

U.S. EPA Tier 3 and EU Stage 3A emissions equivalent.



HYDRAULICS

Type .. HydraulMind (Hydraulic Mechanical Intelligence New Design) system, closed-center system with load sensing valves and pressure compensated valves
 Number of selectable working modes 6
 Main pump:
 Type Variable displacement piston type
 Pumps for Boom, arm, bucket, swing, and travel circuits
 Maximum flow 439 L/min
 Supply for control circuit Self-reducing valve
 Hydraulic motors:
 Travel 2 x axial piston motor with parking brake
 Swing 1 x axial piston motor with swing holding brake
 Relief valve setting:
 Implement circuits 37.3 MPa 380 kg/cm²
 Travel circuit 37.3 MPa 380 kg/cm²
 Swing circuit 28.9 MPa 295 kg/cm²
 Pilot circuit 3.2 MPa 33 kg/cm²
 Hydraulic cylinders:
 (Number of cylinders – bore x stroke x rod diameter)
 Boom 2–120 mm x 1334 mm x 85 mm
 Arm 1–135 mm x 1490 mm x 95 mm
 Bucket for 2.93 m arm 1–115 mm x 1120 mm x 80 mm
 for 2.41 m arm 1–115 mm x 1120 mm x 80 mm
 for 1.84 m arm 1–125 mm x 1110 mm x 85 mm



DRIVES AND BRAKES

Steering control Two levers with pedals
 Drive method Hydrostatic
 Maximum drawbar pull 178 kN 18200 kg
 Grade ability 70%, 35°
 Maximum travel speed: High 5.5 km/h
 (Auto-shift) Mid 4.1 km/h
 (Auto-shift) Low 3.0 km/h
 Service brake Hydraulic lock
 Parking brake Mechanical disc brake



SWING SYSTEM

Drive method Hydrostatic
 Swing reduction Planetary gear
 Swing circle lubrication Grease-bathed
 Service brake Hydraulic lock
 Holding brake/Swing lock Mechanical disc brake
 Swing speed 12.4 min⁻¹



UNDERCARRIAGE

Center frame X-frame
 Track frame Box-section
 Seal of track Sealed track
 Track adjuster Hydraulic
 Number of shoes (Each side):
 PC200-8M0 45
 PC200LC-8M0 49
 Number of carrier rollers 2 each side
 Number of track rollers (Each side):
 PC200-8M0 7
 PC200LC-8M0 9



COOLANT AND LUBRICANT CAPACITY (REFILLING)

Fuel tank 400 L
 Coolant 20.4 L
 Engine 23.1 L
 Final drive (Each side) 3.6 L
 Swing drive 6.5 L
 Hydraulic tank 135 L



OPERATING WEIGHT (APPROXIMATE)

Operating weight including 5700 mm one-piece boom, 2925 mm arm, SAE J 296 heaped 0.80 m³ backhoe bucket, rated capacity of lubricants, coolant, full fuel tank, operator, and standard equipment.

Shoes	PC200-8M0		PC200LC-8M0	
	Operating Weight	Ground Pressure	Operating Weight	Ground Pressure
600 mm	19900 kg	46.1 kPa 0.47 kg/cm ²	20700 kg	43.1 kPa 0.44 kg/cm ²
700 mm	20200 kg	40.2 kPa 0.41 kg/cm ²	21100 kg	37.2 kPa 0.38 kg/cm ²
800 mm	20500 kg	35.3 kPa 0.36 kg/cm ²	21400 kg	33.3 kPa 0.34 kg/cm ²



DIMENSIONS

Arm Length	1840 mm	2410 mm	2925 mm
A Overall length	9480 mm	9495 mm	9425 mm
B Length on ground (Transport): PC200-8M0 PC200LC-8M0	6270 mm	5700 mm	4815 mm
	6455 mm	5885 mm	5000 mm
C Overall height (To top of boom)	2985 mm	3190 mm	2970 mm

	PC200-8M0	PC200LC-8M0
D Overall width	2800 mm	3080 mm
E Overall height (To top of cab)	3040 mm	3040 mm
F Ground clearance, counterweight	1085 mm	1085 mm
G Ground clearance (Minimum)	440 mm	440 mm
H Tail swing radius	2750 mm	2750 mm
I Track length on ground	3275 mm	3655 mm
J Track length	4070 mm	4450 mm
K Track gauge	2200 mm	2380 mm
L Width of crawler	2800 mm	3080 mm
M Shoe width	600 mm	700 mm
N Grouser height	26 mm	26 mm
O Machine cab height	2095 mm	2095 mm
P Machine cab width	2710 mm	2710 mm
Q Distance, swing center to rear end	2710 mm	2710 mm

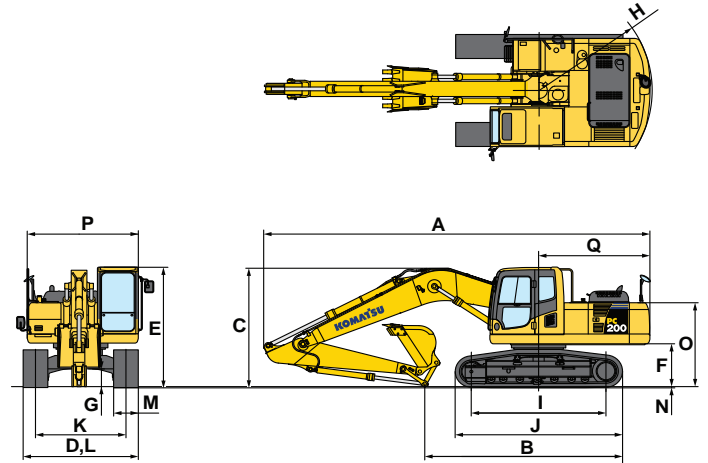

WORKING RANGE

Arm Length	1840 mm	2410 mm	2925 mm	
A Max. digging height	9500 mm	9800 mm	10000 mm	
B Max. dumping height	6630 mm	6890 mm	7110 mm	
C Max. digging depth	5380 mm	6095 mm	6620 mm	
D Max. vertical wall digging depth	4630 mm	5430 mm	5980 mm	
E Max. digging depth of cut for 2440 mm level	5130 mm	5780 mm	6370 mm	
F Max. digging reach	8850 mm	9380 mm	9875 mm	
G Max. digging reach at ground level	8660 mm	9190 mm	9700 mm	
H Min. swing radius	3010 mm	3090 mm	3040 mm	
SAE 1179 Rating	Bucket digging force at power max.	157 kN 16000 kg	138 kN 14100 kg	138 kN 14100 kg
	Arm crowd force at power max.	139 kN 14200 kg	124 kN 12600 kg	101 kN 10300 kg
ISO 6015 Rating	Bucket digging force at power max.	177 kN 18000 kg	149 kN 15200 kg	149 kN 15200 kg
	Arm crowd force at power max.	145 kN 14800 kg	127 kN 13000 kg	108 kN 11000 kg

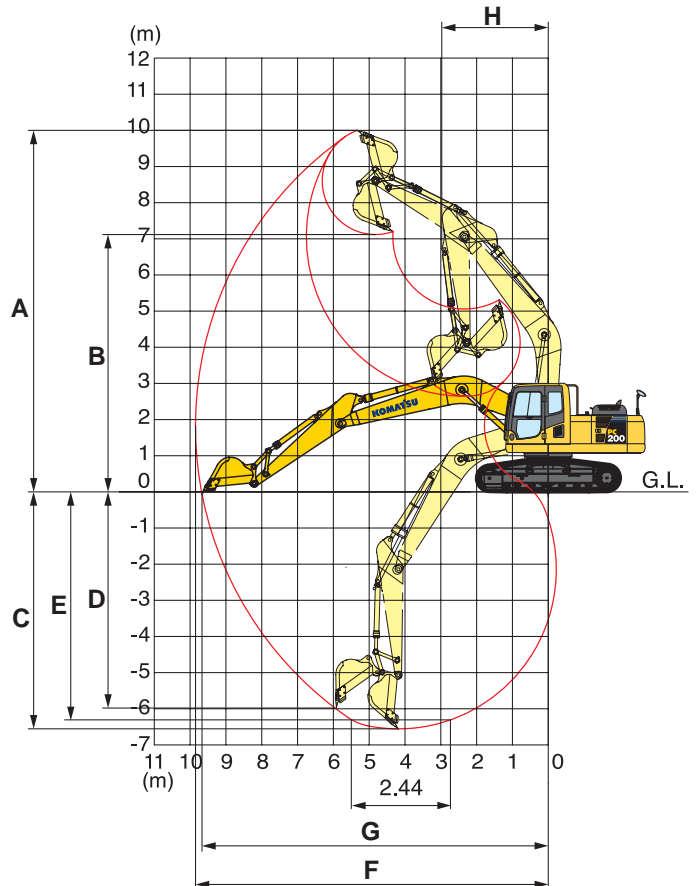



LIFTING CAPACITY WITH LIFTING MODE

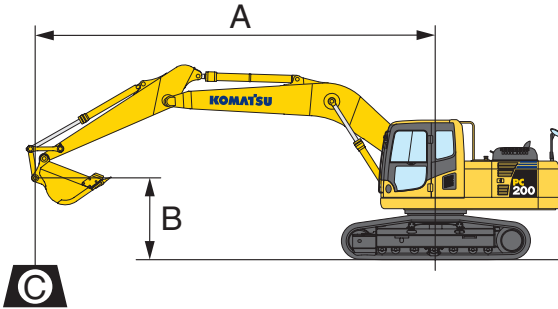

- A: Reach from swing center
- B: Bucket hook height
- C: Lifting capacity
- Cf: Rating over front
- Cs: Rating over side
- ⊗: Rating at maximum reach

- Conditions:
- 5700 mm one-piece boom
 - 0.8 m³ SAE J 296 heaped bucket
 - Shoe width:
 - PC200-8M0 600 mm triple grouser

PC200-8M0		Arm: 1840 mm		Bucket: 0.8 m ³ SAE J 296 heaped		Shoe: 600 mm triple grouser							
B	A	⊗ MAX		7.5 m		6.0 m		4.5 m		3.0 m		1.5 m	
		Cf	Cs	Cf	Cs	Cf	Cs	Cf	Cs	Cf	Cs	Cf	Cs
7.5 m		*5100 kg	*5100 kg					*5600 kg	*5600 kg				
6.0 m		*4800 kg	3600 kg			*5550 kg	3950 kg	*5800 kg	*5800 kg				
4.5 m		4400 kg	2850 kg			5850 kg	3800 kg	*7350 kg	6150 kg	*10350 kg	*10350 kg		
3.0 m		3900 kg	2500 kg	3850 kg	2450 kg	5600 kg	3600 kg	9000 kg	5650 kg				
1.5 m		3750 kg	2350 kg	3750 kg	2350 kg	5400 kg	3400 kg	8550 kg	5200 kg				
0 m		3900 kg	2400 kg	3700 kg	2300 kg	5250 kg	3250 kg	8350 kg	5050 kg				
-1.5 m		4400 kg	2750 kg			5200 kg	3250 kg	8350 kg	5050 kg	*9500 kg	*9500 kg		
-3.0 m		5750 kg	3600 kg			5350 kg	3350 kg	8500 kg	5200 kg	*13000 kg	10300 kg		

PC200-8M0		Arm: 2410 mm		Bucket: 0.8 m ³ SAE J 296 heaped		Shoe: 600 mm triple grouser							
B	A	⊗ MAX		7.5 m		6.0 m		4.5 m		3.0 m		1.5 m	
		Cf	Cs	Cf	Cs	Cf	Cs	Cf	Cs	Cf	Cs	Cf	Cs
7.5 m		*4500 kg	4250 kg										
6.0 m		*4250 kg	3000 kg			*4850 kg	4050 kg						
4.5 m		3800 kg	2450 kg	4000 kg	2600 kg	*5450 kg	3900 kg	*6400 kg	6300 kg				
3.0 m		3450 kg	2150 kg	3900 kg	2500 kg	5650 kg	3650 kg	*8650 kg	5800 kg				
1.5 m		3300 kg	2050 kg	3750 kg	2350 kg	5450 kg	3450 kg	8650 kg	5300 kg				
0 m		3400 kg	2100 kg	3700 kg	2300 kg	5250 kg	3250 kg	8350 kg	5050 kg	*7000 kg	*7000 kg		
-1.5 m		3750 kg	2350 kg	3650 kg	2250 kg	5200 kg	3200 kg	8300 kg	5000 kg	*9300 kg	*9300 kg	*7700 kg	*7700 kg
-3.0 m		4650 kg	2900 kg			5250 kg	3250 kg	8400 kg	5100 kg	*14600 kg	10200 kg		
-4.5 m		*7150 kg	4500 kg					*8300 kg	5350 kg	*11650 kg	10400 kg		

PC200-8M0		Arm: 2925 mm		Bucket: 0.8 m ³ SAE J 296 heaped		Shoe: 600 mm triple grouser							
B	A	⊗ MAX		7.5 m		6.0 m		4.5 m		3.0 m		1.5 m	
		Cf	Cs	Cf	Cs	Cf	Cs	Cf	Cs	Cf	Cs	Cf	Cs
7.5 m		*2900 kg	*2900 kg			*4050 kg	*4050 kg						
6.0 m		*2750 kg	2600 kg	*3100 kg	2600 kg	*4250 kg	4100 kg						
4.5 m		*2750 kg	2150 kg	4000 kg	2550 kg	*4850 kg	3900 kg	*5500 kg	*5500 kg				
3.0 m		*2900 kg	1900 kg	3850 kg	2450 kg	5650 kg	3650 kg	*7700 kg	5850 kg	*11600 kg	11450 kg		
1.5 m		2950 kg	1800 kg	3700 kg	2300 kg	5400 kg	3400 kg	8700 kg	5300 kg	*6800 kg	*6800 kg		
0 m		3000 kg	1800 kg	3600 kg	2200 kg	5150 kg	3200 kg	8300 kg	4950 kg	*5150 kg	*5150 kg		
-1.5 m		3300 kg	2000 kg	3550 kg	2150 kg	5050 kg	3050 kg	8100 kg	4850 kg	*9300 kg	*9300 kg	*5150 kg	*5150 kg
-3.0 m		3950 kg	2400 kg			5050 kg	3100 kg	8200 kg	4900 kg	*14800 kg	9850 kg	*9700 kg	*9700 kg
-4.5 m		5700 kg	3500 kg					8400 kg	5100 kg	*12950 kg	10200 kg		

* Load is limited by hydraulic capacity rather than tipping. Ratings are based on SAE J1097. Rated loads do not exceed 87% of hydraulic lift capacity or 75% of tipping load.



LIFTING CAPACITY WITH LIFTING MODE

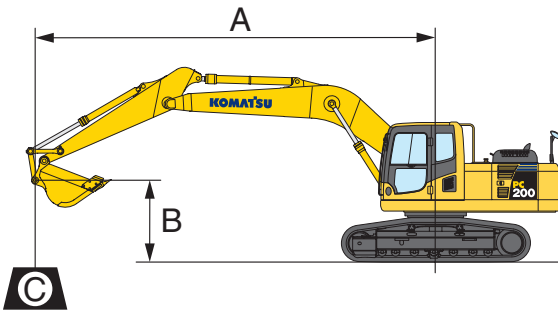

- A: Reach from swing center
- B: Bucket hook height
- C: Lifting capacity
- Cf: Rating over front
- Cs: Rating over side
- ⊗: Rating at maximum reach

Conditions:

- 5700 mm one-piece boom
- 0.8 m³ SAE J 296 heaped bucket
- Shoe width:
 - PC200LC-8M0 700 mm triple grouser

PC200LC-8M0 Arm: 1840 mm Bucket: 0.8 m ³ SAE J 296 heaped Shoe: 700 mm triple grouser													
B	A	⊗ MAX		7.5 m		6.0 m		4.5 m		3.0 m		1.5 m	
		Cf	Cs	Cf	Cs	Cf	Cs	Cf	Cs	Cf	Cs	Cf	Cs
7.5 m		*5100 kg	*5100 kg					*5600 kg	*5600 kg				
6.0 m		*4800 kg	4150 kg			*5550 kg	4550 kg	*5800 kg	*5800 kg				
4.5 m		*4900 kg	3300 kg	4750 kg	2900 kg	*6000 kg	4400 kg	*7350 kg	7050 kg	*10350 kg	*10350 kg		
3.0 m		4850 kg	2900 kg	4650 kg	2800 kg	6900 kg	4200 kg	*9700 kg	6550 kg				
1.5 m		4650 kg	2800 kg	4600 kg	2750 kg	6700 kg	4000 kg	*10700 kg	6100 kg				
0 m		4850 kg	2850 kg			6550 kg	3850 kg	10600 kg	5950 kg				
-1.5 m		5450 kg	3250 kg			6500 kg	3800 kg	*10600 kg	5950 kg	*9500 kg	*9500 kg		
-3.0 m		7150 kg	4200 kg			6650 kg	3950 kg	*9750 kg	6100 kg	*13000 kg	12250 kg		

PC200LC-8M0 Arm: 2410 mm Bucket: 0.8 m ³ SAE J 296 heaped Shoe: 700 mm triple grouser													
B	A	⊗ MAX		7.5 m		6.0 m		4.5 m		3.0 m		1.5 m	
		Cf	Cs	Cf	Cs	Cf	Cs	Cf	Cs	Cf	Cs	Cf	Cs
7.5 m		*4500 kg	*4500 kg										
6.0 m		*4250 kg	3500 kg			*4850 kg	4650 kg						
4.5 m		*4300 kg	2850 kg	4900 kg	3000 kg	*5450 kg	4500 kg	*6400 kg	*6400 kg				
3.0 m		4250 kg	2550 kg	4800 kg	2900 kg	*6400 kg	4200 kg	*8650 kg	6750 kg				
1.5 m		4100 kg	2450 kg	4700 kg	2800 kg	6750 kg	4000 kg	*10550 kg	6250 kg				
0 m		4250 kg	2500 kg	4600 kg	2700 kg	6550 kg	3850 kg	10650 kg	5950 kg	*7000 kg	*7000 kg		
-1.5 m		4700 kg	2750 kg	4550 kg	2700 kg	6500 kg	3800 kg	10550 kg	5900 kg	*9300 kg	*9300 kg	*7700 kg	*7700 kg
-3.0 m		5800 kg	3400 kg			6550 kg	3850 kg	*10350 kg	6000 kg	*14600 kg	12200 kg		
-4.5 m		*7150 kg	5250 kg					*8300 kg	6250 kg	*11650 kg	*11650 kg		

PC200LC-8M0 Arm: 2925 mm Bucket: 0.8 m ³ SAE J 296 heaped Shoe: 700 mm triple grouser													
B	A	⊗ MAX		7.5 m		6.0 m		4.5 m		3.0 m		1.5 m	
		Cf	Cs	Cf	Cs	Cf	Cs	Cf	Cs	Cf	Cs	Cf	Cs
7.5 m		*2900 kg	*2900 kg			*4050 kg	*4050 kg						
6.0 m		*2750 kg	*2750 kg	*3100 kg	3050 kg	*4250 kg	*4250 kg						
4.5 m		*2750 kg	2550 kg	*4600 kg	3000 kg	*4850 kg	4500 kg	*5500 kg	*5500 kg				
3.0 m		*2900 kg	2250 kg	4800 kg	2850 kg	*5900 kg	4200 kg	*7700 kg	6800 kg	*11600 kg	*11600 kg		
1.5 m		*3200 kg	2150 kg	4600 kg	2750 kg	6700 kg	3950 kg	*9800 kg	6250 kg	*6800 kg	*6800 kg		
0 m		*3700 kg	2200 kg	4500 kg	2600 kg	6500 kg	3750 kg	10550 kg	5850 kg	*5150 kg	*5150 kg		
-1.5 m		4150 kg	2400 kg	4450 kg	2550 kg	6350 kg	3650 kg	10400 kg	5750 kg	*9300 kg	*9300 kg	*5150 kg	*5150 kg
-3.0 m		4950 kg	2900 kg			6350 kg	3650 kg	*10400 kg	5800 kg	*14800 kg	11800 kg	*9700 kg	*9700 kg
-4.5 m		*6700 kg	4100 kg					*9100 kg	6000 kg	*12950 kg	*12000 kg		

* Load is limited by hydraulic capacity rather than tipping. Ratings are based on SAE J1097. Rated loads do not exceed 87% of hydraulic lift capacity or 75% of tipping load.

